

LEARNER **WORKBOOK**

Load and Unload Plant

Trainer's Marking Guide



RII COMPETENCY

Training support material for:
RIIHAN308F
Load and unload plant

 **EASY
GUIDES**
Australia Pty Ltd

PREPARE TO LOAD AND UNLOAD PLANT

Element 1



LOAD THE PLANT CORRECTLY

Element 2



What you need to know to carry plant on a transport vehicle

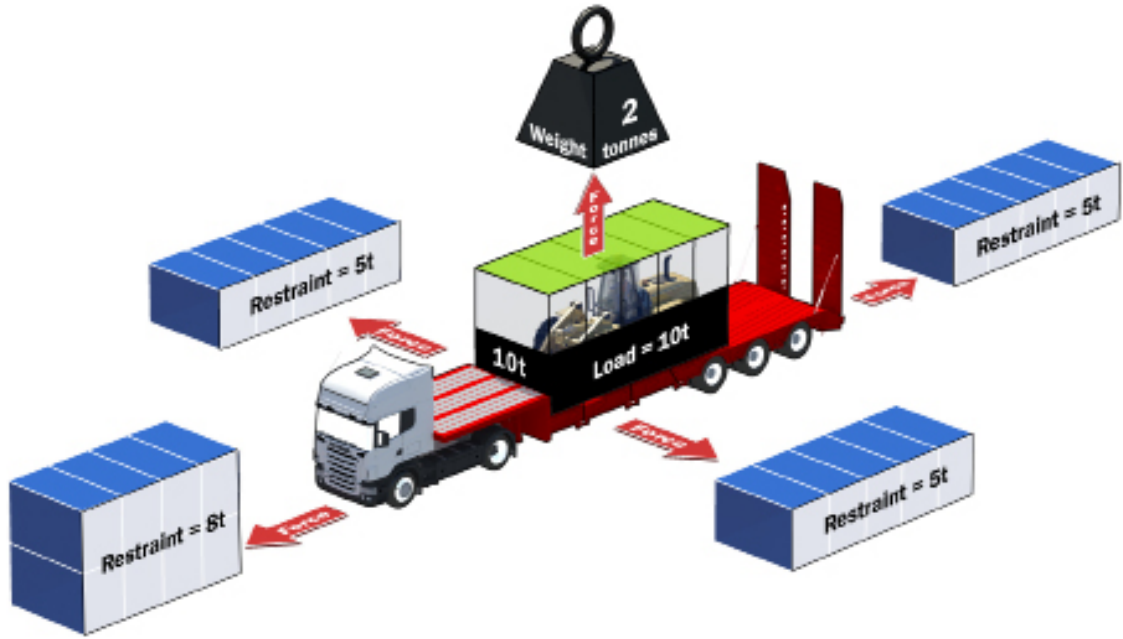

- 1. CAPACITY - How much weight can the transport vehicle carry? How heavy is the plant you want to carry?
- 2. MASS - What is the size of the plant you want to carry? You may need to go through a tunnel or travel on a narrow road.
- 3. LOAD RESTRAINTS - What type and how many load restraints do you need to hold the plant down securely?

Notes



50. Question: What 3 things do you need to plan for when loading or unloading plant onto a transport truck?
Answer: Capacity, mass and load restraints.

Set up the transport vehicle to carry an excavator

Example of moving plant:

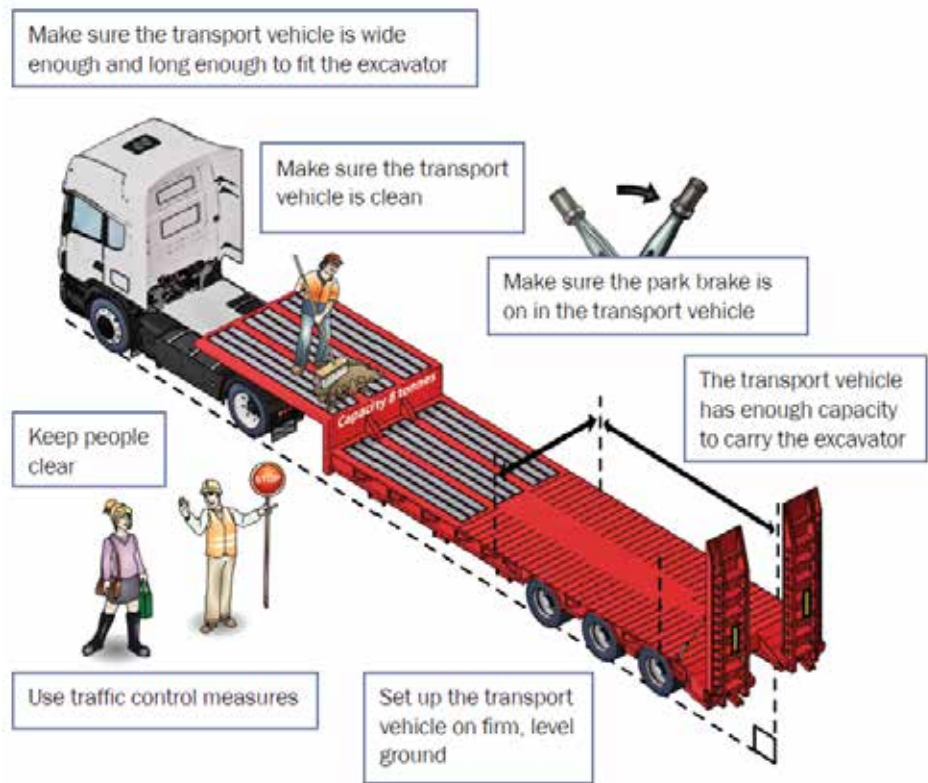

[Continued on next page.]

Notes



51. Question: Should the parking brake of the transport vehicle be on when loading or unloading plant?

Answer: Yes.

After the transport vehicle and the excavator have been prepared, what steps are taken?

1. Raise the bucket to clear the ground.



2. Drive to the loading area.



3. Line the machine up with the ramps.

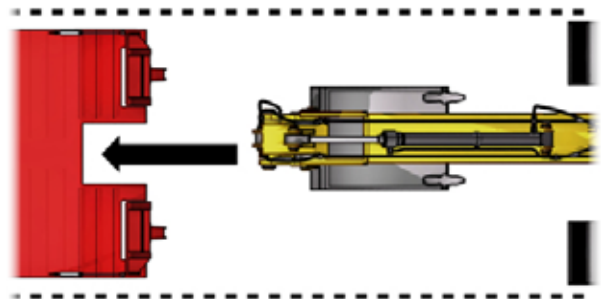

[Continued on next page.]

Notes



52. Question: What is the third thing you should do when loading plant onto a transport vehicle?

Answer: Line the machine up with the ramps.

.....
.....
.....
.....
.....
.....
.....
.....
.....
.....
.....
.....
.....
.....
.....

4. Drive slowly forward until the tracks or wheels start to climb the ramp.

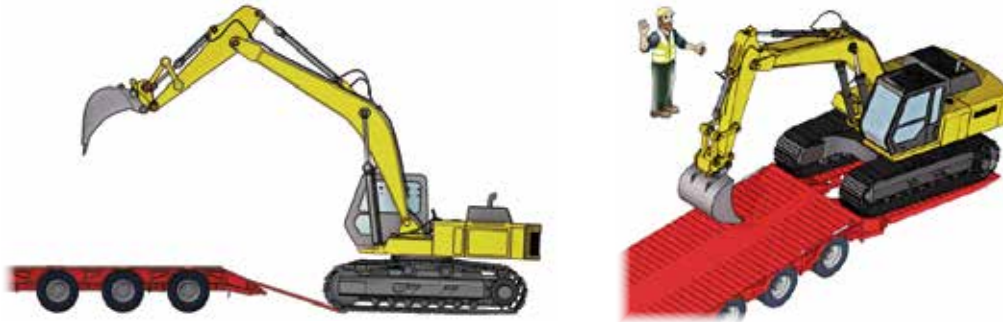

If visibility is restricted a guide may be required.

5. Move the bucket or attachment away from the machine to help balance the machine while climbing ramps.



[Continued on next page.]

Notes



53. Question: When loading, why should you move the bucket or attachment away from the machine?

Answer: To help balance the plant while climbing ramps.

.....

.....

.....

.....

.....

.....

.....

.....

.....

.....

.....

.....

.....

.....

.....

.....

.....

.....

.....

.....

.....

.....

- 6. Lower the bucket to the vehicle deck and drive slowly forward while moving the attachment closer to the cab and supporting the front of the machine.



- 7. As the machine rocks over onto the deck raise the bucket slowly to prevent the machine coming down hard onto the deck.



- 8. Raise the bucket until it just clears the deck and position the machine on the vehicle to make sure the load is correctly shared by the wheels.



- 9. Move the bucket close to the operator's platform and lower the boom down until the boom weight is resting on the deck.



[Continued on next page.]

Notes



54. Question: Why should you raise the bucket slowly as the machine/plant rocks over onto the deck?

Answer: To prevent the machine coming down hard onto the deck.

.....

.....

.....

.....

.....

.....

.....

.....

.....

.....

.....

.....

.....

.....

.....

.....

.....

.....

.....

.....

.....

.....

.....

10. Switch off the machine and apply the park brake.



11. Secure the cabin.



12. Secure the machine to the vehicle.

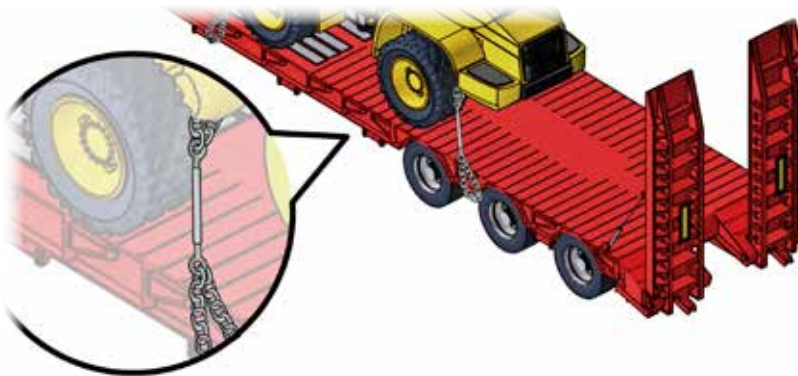

Notes



55. Question: What is the last thing you should do when loading plant onto a transport vehicle?

Answer: Secure the machine/plant to the transport vehicle.

A series of horizontal dotted lines for writing additional notes or answers.

Machinery dimensions

You need to know the weight and dimensions of the float or trailer to safely carry the plant. This will help you to know that you have the right transport vehicle to do the job.

For example: Which float would you use?

Barry Smith has been asked to transport an excavator weighing 52 tonne with a track width of 3.2 meters, the company Barry works for has two floats in the transport pool.

- A) 1 Drake widening 4x4 float timber deck and drake 2x4 dolly non widening
- B) 1 Lusty 4x8 axle steel deck widening float and 2x8 dolly widening.

1 Which float would be used?

Answer:

Barry should use the 4x8 Lusty float. A 4x4 even with the dolly is only good for 50 tonne. Legal compliance build plates on the float and will have details including gross vehicle mass (GVM) and tare weight.

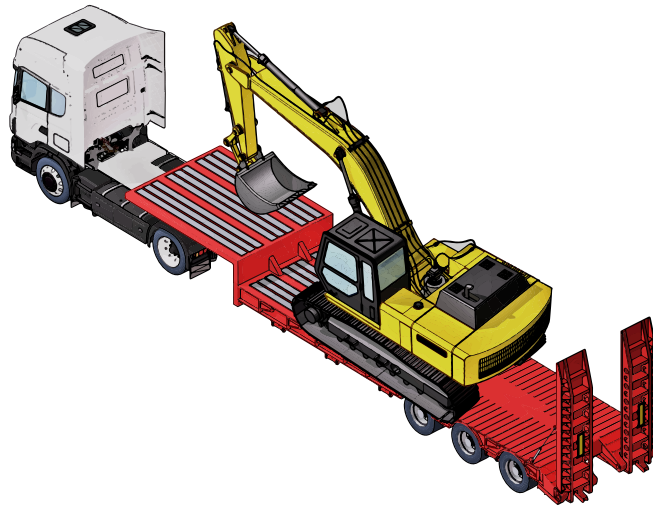

[Note: Gross Vehicle Mass (GVM) is the maximum total weight that a truck can apply to the ground.]

Notes



56. Question: Why is it important to know the weight and dimensions of the float or trailer?

Answer: This will help you to know that you have the right transport vehicle to do the job.

.....

.....

.....

.....

.....

.....

.....

.....

.....

.....

.....

.....

.....

.....

.....

.....

.....

.....

.....

.....

.....

.....

Dimensions and capacity of the float or trailer

How to calculate weight of plant?

- Check operator's manual
- Or check decal plate on plant
- Or contact manufacturer
- Or check Internet



check Internet



operator's manual



decal plate



Notes

58. Question: How can you check the weight of the plant you will carry?

Answer: Check the operator's manual,

or check the decal on the plant,

or contact the manufacturer,

or check on the Internet.

How to calculate volume/dimensions of plant?

Calculate volume/dimensions of plant

volume = (length x height x width)

- Height-measure with telescopic height pole
- Width and length-use tape measure or check operator's manual

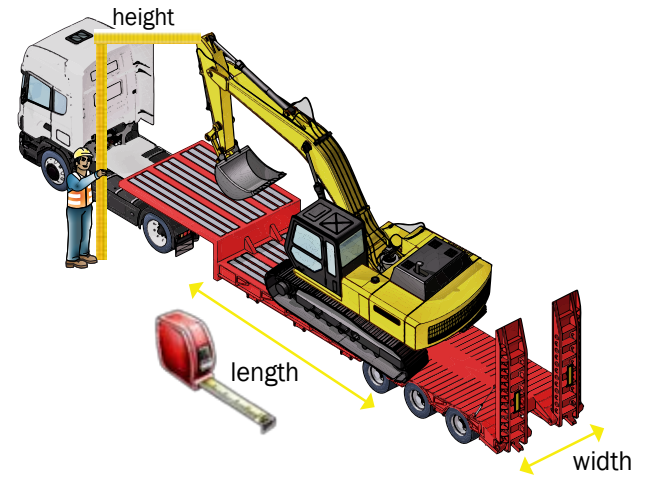

Example - Can you transport a 4T skid steer loader

Rating of trailer = 7T

Weight of skid steer loader = 4T

Weight of bucket attachment = 1.5T



Answer: The trailer has a rating of 7 tonne. The skid steer and bucket attachment combined have a weight of 5.5 tonne.

This allows 1.5 tonne of excess, so yes, the skid steer could be loaded and carried on the trailer.

Notes



59. Question: Can this trailer carry an excavator of 12 tonnes including the attachment?

Answer: No. The trailer has a rating of only 7 tonne.

.....

.....

.....

.....

.....

.....

.....

.....

.....

.....

.....

.....

.....

.....

.....

.....

.....

.....

.....

.....

.....